

Operating Instructions
Read and observe these Operating Instructions!

Recirculating Cooler

C 900



KNF Neuberger GmbH
Alter Weg 3
79112 Freiburg
Germany
Tel. +49 (0)7664 / 5909-0
Fax +49 (0)7664 / 5909-99
E-mail: info@knf.de
www.knf.de

Contents

Page

1. About this document.....	3
2. Intended use.....	4
3. Operator responsibility – Safety precautions	5
4. Handling	6
5. Technical data	8
6. Safety precautions.....	11
7. Transportation, setup, and connection.....	14
8. Operating and functional elements	17
9. Initial start-up.....	19
10. Protective features	25
11. Troubleshooting guide / Alarm messages.....	26
12. Cleaning / repairing the unit	28
13. Accessories	30
14. Returns.....	31
15. Health and safety clearance and decontamination form.....	32

1. About this document

The Operating Instructions are an integral part of the recirculating cooler.

- Carefully read the Operating Instructions before bringing the recirculating cooler into operation.
- Keep the Operating Instructions readily accessible at all times.
- Pass on the Operating Instructions to the next owner.

i Compliance with the Operating Instructions is essential for safe and reliable operation of the recirculating cooler. Failure to observe the Operating Instructions may result in damage or injury.

2. Intended use

The KNF Recirculating Cooler is designed to control the temperature of certain liquid media.

External pump connections enable constant-temperature cooling of applications in an external loop.



PID1

This recirculating cooler is operated via the splash-proof membrane keypad. Microprocessor technology enables adjustment, display, and storage of the setpoint through the LED temperature display.

The PID temperature regulation is used to withdraw heat from the heat transfer liquid by means of the cooling apparatus and to automatically regulate the required need.



NOTE

Health hazards associated with the heat transfer liquid

→ KNF recirculating coolers are not intended for direct temperature control of food and luxury articles, pharmaceutical products, or medical devices.

Direct temperature control means:

Unprotected contact of the object with the bath medium (heat transfer liquid).

3. Operator responsibility – Safety precautions

The products of KNF Neuberger GmbH ensure safe operation when installed, operated, and maintained according to common safety regulations. This section explains the potential dangers that may arise when operating the recirculating cooler and also specifies the most important safety precautions to preclude these dangers as far as possible.

- The operator is responsible for the qualification of the personnel operating the units.
- Make sure that the persons who operate the recirculating cooler are trained in this work.
- The personnel operating the units should be regularly instructed about the dangers involved with their job activities as well as measures to avert these dangers.
- Make sure all persons tasked with operating, installing, and maintaining the unit have read and understood the safety information and Operating Instructions.
- When using hazardous materials or materials that could become hazardous, the recirculating cooler may be operated only by persons who have complete familiarity with these materials and the recirculating cooler. These persons must be fully aware of possible risks.

If you have any questions concerning the operation of your unit or the information in this manual, please contact us (see final page for telephone number)!

4. Handling

- Avoid strikes to the housing, vibrations, damage to the keypad (keys, display), and heavy contamination.
- Make sure the product is regularly checked for proper condition (depending on the conditions of use).
- Regularly check (at least every 2 years) the condition of the mandatory, warning, prohibition and safety labels.
- Make sure that the mains power supply has low impedance to avoid any negative effects on instruments being operated on the same mains.
- This unit is designed for operation in a controlled electromagnetic environment. Accordingly, transmitting devices such as mobile telephones shall not be used in the immediate vicinity. Other devices with magnetically sensitive components, such as a monitor, may be influenced by magnetic radiation. We recommend maintaining a minimum distance of 1 m.
- Permissible ambient temperature: max. 40 °C, min. 5 °C.
- Permissible relative humidity: 50% (40 °C).
- Do not store the unit in an aggressive atmosphere. Protect the unit from contamination.
- Do not expose the unit to sunlight.

4.1. Appropriate operation

Only qualified personnel are authorized to perform configuration, installation, maintenance and repairs of the recirculating cooler. The operator of the cooler must be trained by technical personnel.

4.2. Use



DANGER



Ignition of potentially explosive mixtures

- The unit is not for use in a potentially explosive atmosphere.

Special materials specifications (heat transfer liquids) must be observed in order to comply with the intended use. Neither corrosive nor corrosive-acting heat transfer liquids may be used. Observe all warnings for the used materials (heat transfer liquids) and the respective instructions (safety data sheets).

Provide for adequate ventilation at the place of installation (see Page 14).

When using hazardous materials or materials that could become hazardous, **the operator must** affix the enclosed safety labels (**1 + 2**) to the front of the unit so they are highly visible:

1		Warning of a danger area. Attention! Please observe the documentation. (Operating Instructions, safety data sheet)
2a		Carefully read the user information prior to switching on the unit. Area of applicability: EU
or		
2b		Carefully read the user information prior to switching on the unit. Area of applicability: United States, NAFTA

Tab. 1

4.3. Disposal

This unit contains the refrigerant R134a – at this time considered not to have any negative effects on the ozone layer. However, during the long operating period of the unit, disposal regulations may change. Therefore, only qualified personnel shall perform disposal.



Area of applicability: EU nations

See the current official journal of the European Union – WEEE directive.

Directive of the European Parliament and of the Council on Waste Electrical and Electronic Equipment (WEEE).

This directive requires electrical and electronic equipment marked with a crossed-out trash can to be disposed of separately in an environmentally friendly manner.

Please contact an authorized disposal company in your country.

Disposal with household waste (unsorted waste) or through similar facilities for collecting community waste is not permitted!

5. Technical data

5.1. C 900

<i>Recirculating Cooler</i>	
Working temperature range	-10 °C to +40 °C
Temperature stability	±0.5 °C
Temperature selection:	digital
locally via keypad	LED DISPLAY
Temperature indication:	LED DISPLAY
Adjustment and display resolution	0.1 °C
Temperature control	PID 1
Working temperature sensor	Pt 100
High temperature cut-off	85 °C - fixed value
Low-liquid-level protection	Float switch
<i>Circulating pump</i>	
Flow rate [l/min] max. at 0 bar	15
Pressure [bar] max. at 0 liter	0.35
Fill level indicator	Sight glass
Fill volume [liter] from ... to	1.7 ... 2.6
Dimensions [mm] (WxDxH)	240 x 400 x 520
Weight [kg]	27.0
Permissible ambient temperature range [°C]	5 ... 40
Permissible return temperature [°C]	max. 80
<i>single-stage / air-cooled refrigeration compressor</i>	
Refrigerant	R134a
Cooling capacity [°C/W] at 115 V / 60 Hz at 230 V / 50 Hz	$\frac{+20}{250}$, $\frac{+15}{240}$, $\frac{+10}{220}$, $\frac{+5}{210}$, $\frac{0}{180}$, $\frac{-5}{90}$, $\frac{-10}{60}$
Medium: Water-glycol mixture	
<i>Electrical data</i>	
Power supply 230 V / 50 Hz	207-253 V / 50 Hz
Operating current [A] (at 230 V)	3.0
Power supply 115 V / 60 Hz	115 V / 60 Hz
Operating current [A] (at 115 V)	4.4

Tab. 2

All measurements taken at rated voltage and frequency

Ambient temperature 20 °C

5.2. Warning and safety precautions

<i>Warning and safety precautions</i>	
High temperature cut-off, fixed value	85 °C
Low-liquid-level protection	Float switch
Alarms	optical + audible (permanent)
Overload protection	for cooling machine and pump motor
Classification according to DIN 12876-1	Class I

Tab. 3

Ambient conditions according to EN 61 010-1:

- For indoor use only.
- Up to 2000 m elevation – Standard zero
- Ambient temperature: +5 ... +40 °C
- Humidity:
Max. relative humidity 80% for temperatures up to +31 °C,
linear decrease down to 50% relative humidity at a temperature of +40 °C
- Voltage fluctuations of $\pm 10\%$ are permissible.

Standards The recirculating cooler meets the safety stipulations of Directive 2004/108/EC for electromagnetic compatibility, Directive 2006/42/EC for machines, and Directive 2011/65/EU (RoHS2). The following harmonized standards are fulfilled:

- EN 61010-1
- EN 61010-2-010
- EN 61326-1
- EN 378-1/2/3/4

The recirculating cooler complies with the following according to IEC 664:

- Protection class I
- Overvoltage category II
- Contamination level 2



DANGER

Ignition of potentially explosive mixtures

→ The unit is not for use in potentially explosive atmospheres.

EMC requirements:

This unit is an ISM device of Group 1 (using high frequency for internal purposes) and is categorized in Class A (industrial and commercial field).

5.3. Materials used on liquid-contacting parts

<i>Description</i>	<i>Material</i>
PVC tube (liquid level indicator)	PVC
Plug	PA
Reservoir, all components	1.4404, 1.4301, 1.4435
Screw plug	1.4571
Profile gasket	Silicone, white
Upper filler neck	PVC
Stopper	POM
O-ring	CR11-70 (Chloroprene rubber)
Motor mounting plate	
Motor plate	1.4301
Pump	1.4301, 1.4401, PPS (Rytone)
Sensors 2xPt100 metal Installation	1.4571
Float switch	1.4301, PP
Hose fitting	CuZn39Pb3 (nickel plated)

Tab. 4

6. Safety precautions

6.1. Explanation of safety precautions

Warning



WARNING

This symbol indicates a potential danger.

It also indicates the possible consequences of failure to observe the warning. The signal word (e.g. "Warning") indicates the level of danger.

→ Here you will see actions for avoiding the danger and potential consequences.

Danger levels

Signal word	Meaning	Consequences if not observed
DANGER	warns of immediate danger	Consequences are death or serious injury and/or serious property damage
WARNING	warns of potential danger	Death or serious injury and/or serious damage to property are possible
CAUTION	warns of a potentially dangerous situation	Minor injury or damage to property are possible
NOTE	warns of a potentially harmful situation	Damage to the system or something in your surroundings

Tab. 5

6.2. Explanation of other notes

→ This indicates a required activity (step).

1. This indicates the first step of a required activity. Additional consecutively numbered steps follow.

i This symbol indicates important information.

6.3. Safety instructions

To avoid personal injury and property damage, it is important to follow the safety instructions. These instructions supplement workplace safety regulations.



Connect the unit only to a mains power socket with ground contact (PE – protective earth)!

These tasks may be performed only by expert personnel.

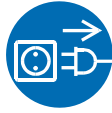

- The mains plug serves as a safe disconnecting device from the power supply and must be always easily accessible.
- Install the unit on an even surface on a pad made of non-inflammable material.
- Read and understand the Operating Instructions before initial operation.
- Never operate the unit without bath fluid!
- Do not drain the heat transfer liquid while hot!
- Check the temperature of the heat transfer liquid prior to draining, e.g. by briefly switching the unit on.
- Use suitable temperature-control tubing.
- Make sure that the tubing is secured against slipping.
- Avoid kinks in the tubing.
- Regularly check the tubing for material fatigue, such as cracks.
- Never operate damaged or leaking equipment.
- Always turn off the unit and disconnect the mains cable from the power source before performing any service or maintenance procedures, or before moving the unit.
- Always turn off the unit and disconnect the mains cable from the power source before cleaning the unit.
- Always completely drain the heat transfer liquid before moving the unit.
- Transport the unit with care.
- Shaking or dropping may also cause damage inside the unit.
- Observe all safety labels!
- Do not remove safety labels!
- Never bring a unit into operation with a damaged mains power cable.
- Service and repairs may be performed by authorized expert personnel only.

**WARNING**

Danger of electric shock! Short circuit with fire hazard!

If the overflow is sealed, the unit may be damaged if overfilled because the liquid will run into the inside of the unit.

Fire hazard when using water/glycol mixture.

→ Do not seal the overflow at the rear of the unit.

7. Transportation, setup, and connection



Heavy loads – danger of crushing

→ Carry the unit with 2 persons.

CAUTION

→ Wear safety shoes.



7.1. Conditions during transportation and during installation

Lifting and Transport:



Caster dolly

- Lift the unit with two persons grasping the bottom of the unit at the front and rear. For transport set the unit on a suitable cast-er dolly (accessory).
- Place the unit on an even surface made of non-flammable material.
- Cooling machine, pump motor and electronics produce heat inside the housing that must be dissipated through ventilation openings.
- Never block the unit's ventilation openings.
- Maintain at least 20 cm of unobstructed space in front of and behind the unit.
- Do not install the unit in the immediate vicinity of heat sources and do not expose it to direct sunlight.
- Ensure good air flow and ventilation of the place of installation.
- The place of installation should be large enough to ensure that the heat dissipated from the unit will not excessively warm the space (max. permissible ambient temperature: +40 °C).
In addition, the standard EN 378 prescribes a certain room space for each kg of refrigerant in the event of refrigerant leakage.
Refer to the type label for the refrigerant volume.
- For 0.25 kg of refrigerant R134a, 1 m³ of space is required.

7.2. Tubing connection





CAUTION

Damage from escaping heat transfer liquid!

- Use suitable temperature-control tubing.
- Secure all tubing connections with hose clamps to prevent slipping.
- Avoid kinks in the tubing.
- Check the tubing for material fatigue (such as cracks) at regular intervals, but at least once per year.
- Preventive maintenance: When subject to moderate wear, the tubing shall be replaced at regular intervals.
- Do not seal  the overflow!
- If the external system is located at a higher level than the recirculating cooler, it may be necessary to prevent the heat transfer liquid from flowing back into the cooler when switched off.

The following questions will help you recognize potential hazards and minimize risks:

- Are all tubes and electrical cables securely connected and installed?
Take note especially of sharp edges, hot surfaces during operation, moving machine parts, etc.
- What must be done if a hazardous substance is spilled onto or into the unit?
Obtain information about the substance before starting work and define decontamination methods.

<i>Tubing connections</i>	
Supply line 	M10x1 outer or hose fitting Ø 8/10 mm ID
Return line 	M10x1 outer or hose fitting Ø 8/10 mm ID

Tab. 6

Refer to Chapter 13 for accessories like tubing, hose fittings, etc.

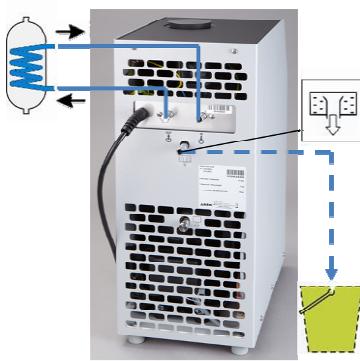

1. Wait approximately one hour after transporting the unit to the place of installation. This will allow any oil that was displaced during transport (e.g. due to vertical position) to flow back down, thus ensuring that the compressor can develop its maximum capacity.
2. Remove screw plugs from the connections.
3. Connect the external system to the pump connectors at the rear of the recirculating cooler using appropriate tubing and hose clamps.

8. Operating and functional elements

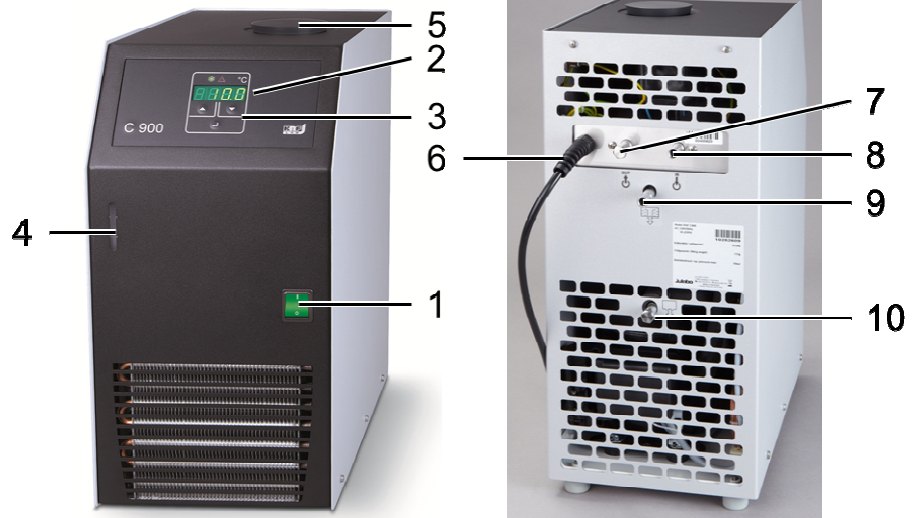

1



Power switch, splash-proof, with integrated safety cutout.

I = On

O = Off

2



Display elements

2(1)



LED temperature display

2(2)



Control display – Cooling

2(3)



Control display – Alarm

3

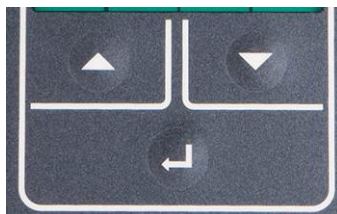





Membrane keypad, splash-proof

3(1)

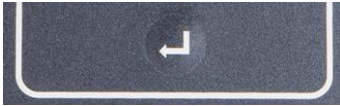

Editing keys
Setpoint higher / lower

3(2)		Enter key Store setpoint / parameter
4		Fill level indicator
5		Filling port , upper
6		Power cable with plug
7		Pump connection – pressure pump , M10x1 outer or hose fitting \varnothing 8/10 mm ID
8		Pump connection – return line , M10x1 outer or hose fitting \varnothing 8/10 mm ID
9		Overflow for bath tank, OD 10 mm, ID 8 mm
10		Drain port , M10x1 outer

9. Initial start-up

9.1. Heat transfer liquids



No liability for use of other heat transfer liquids!

Do not use alcohols.

CAUTION Water:

The quality of water depends on local conditions.

- Due to the high concentration of lime, hard water is not suitable for temperature control because it results in calcification in the bath.
- Water containing iron can cause corrosion – even on stainless steel.
- Water containing chlorine can cause pitting corrosion.
- Distilled and deionized water is unsuitable. Their special properties cause corrosion in the bath, even in stainless steel.
- When water is used, there will be a danger of freezing at temperatures below +5 °C.

Water-glycol mixture:

- Always observe the manufacturer's hazard and safety precautions.
- The water portion may evaporate over time. Regularly check the mixture ratio and add water when necessary.

The recirculating cooler may be used with the following heat transfer liquids:

<i>Heat transfer liquid</i>	<i>Temperature range</i>
KNF heat transfer liquid	-30 °C ... 80 °C
Water/glycol mixture (50:50)	-30 °C ... 50 °C
Soft / decalcified water	+5 °C ... 80 °C

Tab. 7



NOTE

Use of unsuitable heat transfer liquid will result in damage

- Before using a non-recommended heat transfer liquid, always consult with KNF. KNF will assume no liability for damages resulting from use of an unsuitable heat transfer liquid.

9.2. Power connection



DANGER



Danger of electric shock

- Do not use the unit in a potentially explosive atmosphere. The unit may be connected only to power outlets with a protective ground contact!
- The mains plug serves as a safe disconnecting device from the power supply and must be always easily accessible.
- Never bring a unit into operation with a damaged mains power cable.
- Regularly check the mains power cable for damage.
- No liability for improper power connection!

Compare the provided mains voltage and the network frequency to the specifications on the type label. Refer to Chapter 5, Page 8f for permissible voltage deviations.



9.3. Filling

When filling, make sure that no heat transfer liquid penetrates the interior of the recirculating cooler.

(For position see Ch. 8 Operating and functional elements, Pg. 17)

- i** Connect the tubing to the external system and check for leaks.
- i** Make sure the drain port (Pos. 10) is closed.

1. Remove cover from filling opening (Pos. 5).
2. Fill heat transfer liquid to the upper mark on the fill level indicator (Pos. 4).
3. Switch on the recirculating cooler at the power switch (Pos. 1)
4. Start the unit. To do this, press the Enter key  for about 4 seconds.
The unit will start pumping heat transfer liquid into the external system.
5. Add more heat transfer liquid until the upper mark is reached.
The recirculating cooler is now ready for operation.

9.4. Switching the unit On and Off

Switching the unit On:

- Use the power switch (1) to bring the unit into operation.

- i** The unit then performs a self-test, during which the segments of the four-digit LED temperature display and all control lamps will illuminate. The software version and unit model are then displayed.



The **OFF** notification then indicates that the unit is ready for operation.

Start:

- Press the Enter key  for approximately 4 seconds.
The LED will indicate the current bath temperature.



Switching the unit Off:

- Press the Enter key  for approximately 4 seconds.
- Switch off the unit at the power switch.

9.5. Adjusting temperature

Factory setting: 25 °C

i The desired temperature can be selected either in the On or Off state.

1. Briefly press one of the editing keys   in order to switch the display from the actual value to the setpoint value.

i The value will be displayed for approximately 8 seconds. To change the value, you must begin within this time.

2. Changing the value:

Press the editing key  to **increase** the value.

Press the editing key  to **decrease** the value.

Press the key briefly for individual steps; press and hold the key to move quickly through the values.

3. Press Enter key  to store the selected value.



9.6. Timer function

The timer function allows the user to preset the desired operating time.

9.6.1. Setting the time

i The unit must be in the OFF state to change this setting.

1. Retrieving the timer function:

Press and hold the Enter key  and briefly press the editing key . The most recently selected time is displayed.

2. Setting the time:

Press the editing key  to select a higher value.

Press the editing key  to select a lower value. Press the key briefly for individual steps; press and hold the key to move quickly through the values.

3. Press the Enter key  to store the selected value. Example: 120 minutes

i This time will remain in memory until changed.



The max. selectable time is preset at the factory:

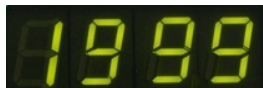

33 h 19 min.

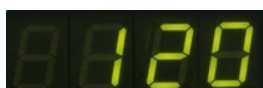

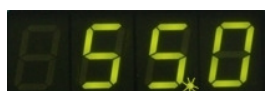

9.6.2. Timer operation

Start timer:



Timer operation

Press and hold the Enter key  and briefly press the editing key .

i The bath temperature is shown. The comma in the display will blink while the timer is running. The selected time is counted down to zero. When the time has elapsed, the recirculating cooler will stop.

Interrupting the timer / Power supply failure:

If there is a power failure, or if the unit is switched off at the power switch, the recirculating cooler will store the time position in its memory. When the power supply is switched on again, the recirculating cooler will operate for the remaining time.

Canceling timer operation:

Press and hold the Enter key  for approximately **4 seconds**. The timer can be restarted.

9.7. Switching AUTOSTART on/off

KNF configures and delivers the recirculating cooler according to the NAMUR recommendations. For starting, this means that the unit must go into a safe operating state after a power failure. This safe operating state is indicated by "OFF" on the LED temperature display.



A complete shutdown of the main functional elements such as compressor and pump motor is effected simultaneously.

The recirculating cooler's selected values remain in memory. The operator can restore operation by pressing and holding the Enter

key  (approx. 4 seconds) in manual operation.

If this safety standard is not required, the NAMUR recommendation can be circumvented with the AUTOSTART function. This enables starting of the recirculating cooler with the power switch directly or with the aid of a timer switch.

Press and hold the **Enter key**  and **switch on** the recirculating cooler with the power **switch**.

The LED display briefly displays the start mode.

 ⇒ = AUTOSTART **on**.

 ⇒ = AUTOSTART **off**.



WARNING

Danger from unattended starting of unit!

→ When starting a recirculating cooler with "AUTOSTART", make sure that unattended starting, e.g. following power failure, will not present a danger to persons or systems. Do not seal the overflow at the rear of the unit.

10. Protective features

10.1. High temperature cut-off



The high temperature cut-off is fixed at 85 °C and is independent of the control circuit. When triggered, the compressor and circulating pump are completely shut down and remain off. The alarm is indicated by optical and audible signals (continuous tone) and the "Error 14" message appears on the LED display.

- i** Check the dimensions of the application.
You may have to use a more powerful recirculating cooler.

10.2. Low-liquid-level protection



This safety feature functions independently of the control circuit. When the low-liquid-level protection device is triggered, the compressor and circulating pump are completely shut down and remain off.

The alarm is indicated optically and acoustically with a continuous audible signal. The "Error 01" message appears on the LED display.

- i** Turn off the unit at the power switch, add heat transfer liquid, and turn the unit on again!



CAUTION

Do not mix heat transfer liquids.

- When refilling, always use the same type of heat transfer liquid that is already in the bath.



NOTE

Inspect the low-liquid-level protection feature at least twice per year.

- To execute a functional test, drain the heat transfer liquid until the low-liquid-level alarm is triggered. Then refill liquid.

11. Troubleshooting guide / Alarm messages

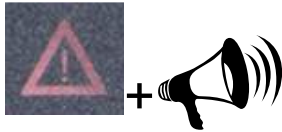

When the following disturbances occur, the compressor and circulation pump of the recirculating cooler are completely shut down and remain off.

The alarm display "" illuminates and a continuous signal tone is emitted. The LED temperature display indicates the cause for the alarm in form of a code.



Press the Enter key  to mute the signal tone.



The recirculating cooler is operated with no or too little heat transfer liquid or the minimum fill level is not met.

➔ Add heat transfer liquid.

Tube breakage has occurred (insufficient filling level due to excessive heat transfer liquid pumped out).

➔ Replace tubing and refill heat transfer liquid.



Cable of the working temperature sensor interrupted or short-circuited.



Working or high-temperature sensor is defective.

Working-temperature and high-temperature sensors report a temperature difference of more than 25 K.



Error in A/D converter.



The return temperature is higher than the high temperature cut-off device's cut-off value of 85 °C.

➔ Check the dimensions of the application.

➔ You may have to use a more powerful recirculating cooler.



The leads to the high-temperature sensor are broken or short-circuited.

1. Switch off the recirculating cooler at the power switch.
2. Wait approx. 2 seconds.
3. Switch on the recirculating cooler at the power switch.

If the error occurs again, a remote diagnosis must be performed.

Disturbances that are not displayed:Overload protection:

- a) for compressor motor
- b) for pump motor

After a short cooling interval, the unit will automatically restart.

Main fuse:

The unit's power switch (1) also serves as a safety cutout.

After a short cooling interval, the unit can be restarted.

12. Cleaning / repairing the unit



DANGER

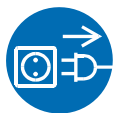

Danger of electric shock

→ Always turn off the unit and disconnect the mains cable from the power source before cleaning the unit.

→ Never allow humidity to enter the unit.

→ Service and repair tasks may be performed by authorized and qualified personnel only.

Front venting grid



Maintain cooling capacity!

To maintain the full cooling performance, clean the condenser at the front of the unit from time to time.

1. Switch off the recirculating cooler at the power switch.
2. Pull the mains power plug.
3. Vacuum (through the front venting grid) any dirt that has collected on the condenser.

Cleaning:

Clean the unit using a cloth and low surface tension water.

The recirculating cooler is designed for continuous operation under normal conditions. Periodic maintenance is not required.

The bath tank should be filled only with a suitable heat transfer liquid. In the event of contamination, it is essential to replace the heat transfer liquid from time to time.

If returning the unit to KNF:

- Observe Chapters 14 and 15!
- Package the unit carefully and properly.
- The unit must be standing upright during shipment. Label the packaging accordingly.



- KNF is not responsible for damages that occur as a result of improper packing.

i KNF reserves the right, in the interest of product improvement, to perform during the repair process any necessary technical changes that contribute to flawless functionality.

12.1. Draining



Danger of electric shock

→ Turn off the unit and disconnect it from the power source.

DANGER

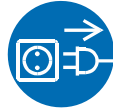

Improper storage and disposal of the heat transfer liquid will result in environmental damages.

→ Always store and dispose of used heat transfer liquid in an environmentally responsible way. Always comply with country-specific regulations for disposal.

NOTE

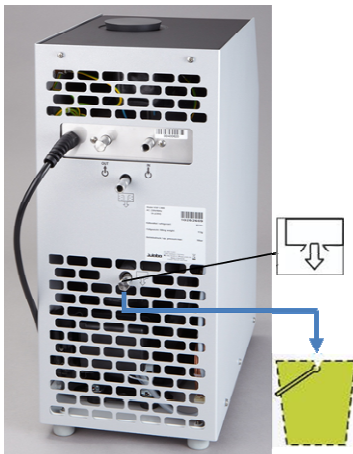

1. Turn off the unit and disconnect it from the power source.
2. Place under the unit a suitable container for capturing the used heat transfer liquid.
3. To drain the heat transfer liquid, unscrew the drain screw at the rear of the unit.
4. Tilt the unit slightly to the rear to enable complete draining.
5. **Close the drain screw** after the complete emptying of the unit.

13. Accessories

Accessories	Order No.
Heat transfer liquid, 5 liters	301143
Heat transfer liquid, 10 liters	301439
Norprene® hose ID10 (sold by the meter*)	028187
Hose fitting ID10 with cap GL14	301198
Caster dolly	301434

Tab. 8

** Indicate desired length in whole meters.*

14. Returns

Pumps and systems used in laboratories and process-based industries are exposed to a wide variety of conditions. This means that the components contacting pumped media could become contaminated by toxic, radioactive, or otherwise hazardous substances.

For this reason, customers who send any pumps or systems back to KNF must submit a Health and safety clearance and decontamination form in order to avoid a hazardous situation for KNF employees. This Health and safety clearance and decontamination form provides the following information, among other things:

- physiological safety
- whether medium-contacting parts have been cleaned
- whether the equipment has been decontaminated
- media that have been pumped or used

and must declare physiological safety. To ensure worker safety, work may not be started on pumps or systems without a signed Health and safety clearance and decontamination form.

For optimal processing of a return, a copy of this declaration should be sent in advance via e-mail, regular mail, or fax to KNF Customer Service (refer to final page for address). In order to avoid endangering employees who open the shipment's packaging, despite any residual hazards, the original version of the Health and safety clearance and decontamination form must accompany the delivery receipt on the outside of the packing.

The template for the Health and safety clearance and decontamination form is included with these Operating Instructions and may also be downloaded from the KNF website.

The customer must specify the device type(s) and serial number(s) in the Health and safety clearance and decontamination form in order to provide for the unambiguous assignment of the Declaration to the device that is sent to KNF.

In addition to the customer's declaration of physiological safety, information about operating conditions and the customer's application are also of importance to ensure that the return shipment is handled appropriately. Therefore, the Health and safety clearance and decontamination form requests this information as well.

15. Health and safety clearance and decontamination form



Form: Rev. 00 / download: www.knf.com

Health and safety clearance and decontamination form

This declaration must be present and complete (the original must accompany the shipment's delivery receipt) before the returned device can be examined.

Device type:

Serial number(s):

.....

.....

Reason for returning the device (please describe in detail):

(The device(s) was(were) in operation yes no)

.....

.....

.....

.....

.....

We confirm that the above device(s)

has(have) pumped exclusively **physiologically unobjectionable** media and that it(they) are free of hazardous materials and any materials that are harmful to health.

The device(s) was(were) cleaned yes no

has(have) pumped media of the following category(categories) which are not physiologically unobjectionable and that cleaning of the device(s) (potentially only media-contacting parts) is required.

Name, chemical formula, Material Safety Data Sheet

aggressive

biological

radioactive

toxic

other

The device(s) was(were) decontaminated and work can proceed without special measures yes

Method / proof:

.....

The device(s) was(were) not decontaminated and special measures are required before starting work yes

Measures:

.....

Legally binding declaration

We herewith affirm that the information provided in this form is correct and complete. Shipment of the devices and components is in compliance with statutory regulations.

.....
Company (stamp)

.....
Date

.....
Name

.....
Authorized signature

.....
Position

KNF worldwide

Benelux

Netherlands
KNF Verder B.V.
Utrechtseweg 4a
NL-3451 GG Vleuten
Tel. 0031 (0)30 677 92 40
Fax 0031 (0)30 677 92 47
E-mail: info@knf-verder.nl
www.knf-verder.nl

Benelux

Belgium, Luxembourg
KNF Verder N.V.
Kontichsesteenweg 17
B-2630 Aartselaar
Tel. 0032 (0)3 8719624
Fax 0032 (0)3 8719628
E-mail: info@knf.be
www.knf.be

China

KNF Neuberger Trading
(Shanghai) Co., Ltd
No. 36 Lane 1000
Zhang Heng Road
Shanghai 201203, P.R. China
Tel. 0086 (0)21 685 965 66
Fax 0086 (0)21 339 006 26
E-mail: info@knf.com.cn
www.knf.com.cn

Germany

KNF Neuberger GmbH
Alter Weg 3
D-79112 Freiburg
Tel. 0049 (0)7664 5909-0
Fax 0049 (0)7664 5909-99
E-mail: info@knf.de
www.knf.de

France, Morocco, Algeria

KNF Neuberger
4, Bld. d'Alsace Z.I.
F-68128 Village-Neuf
Tel. 0033 (0)389 70 35 00
Fax 0033 (0)389 69 92 52
E-mail: info@knf.fr
www.knf.fr

United Kingdom

KNF Neuberger U.K. Ltd.
Avenue 2
Station Lane
Industrial Estate
Witney Oxon OX28 4FA
Tel. 0044 (0)1993 77 83 73
Fax 0044 (0)1993 77 51 48
E-mail: info@knf.co.uk
www.knf.co.uk

India

**KNF Pumps + Systems
(India) Pvt. Ltd.**
RAJIV GANDHI INFOTECH
PARK
Phase 1
Ganga Estate, Survey No. 152/2/2
Above AXIS BANK
Hinjewadi
Pune 411 057
Tel. 0091 (0)20 640 13 923
0091 (0)20 640 08 923
Fax 0091 (0)20 229 33 923
E-mail: info@knfpumps.in
www.knfpumps.in

Italy

KNF ITALIA S.r.l.
Via Flumendosa, 10
I-20132 Milano
Tel. 0039 02 27 20 38 60
Fax 0039 02 27 20 38 48
E-mail: info@knf.it
www.knf.it

Japan

KNF Japan Co.Ltd.
Across Shinkawa Bldg. Annex 3F
1-16-14 Shinkawa, Chuo-ku,
Tokyo, Japan 104-0033
Tel. 0081 (0)3 3551-7931
Fax 0081 (0)3 3551-7932
E-mail: info@knf.co.jp
www.knf.co.jp

Korea

KNF Neuberger Ltd.
Woosan Bldg. RM#202,
336-4, Hwiyung-Dong
Dongdaemun-Ku.,
130-090, Seoul
Tel. 0082 (0)2 959-0255/6
Fax 0082 (0)2 959-0254
E-mail: knf@knfkorea.com
www.knfkorea.com

Sweden, Denmark, Finland, Norway

KNF Neuberger AB
Mejerivägen 4,
P.O. Box 44060
SE-10073 Stockholm
Tel. 0046 (0) 87445113
Fax 0046 (0) 87445117
E-mail: info@knf.se
www.knf.se

Switzerland

Sales
KNF Neuberger AG
Stockenstrasse 6
CH-8362 Balterswil
Tel. 0041 (0)71 973 993 0
Fax 0041 (0)71 973 993 1
E-mail: knf@knf.ch
www.knf.ch

Taiwan

KNF Neuberger Ltd.
9-2 FL., No., 24, Lane 123,
Section 6,
Ming Chuan East Road
Taipei City, Taiwan
Tel. 00886-2-2794-1011
Fax 00886-2-8792-1648
E-mail: knftwn@knftwn.com.tw
www.knftwn.com.tw

United States, Canada, South America

KNF Neuberger, Inc.
Two Black Forest Road
Trenton, NJ
08691-1810
Tel. 001 (609) 890-8600
Fax 001 (609) 890-8323
E-mail: knfusa@knf.com
www.knfusa.com
South America
Direct phone: 001 609-649-1010
E-mail: gb@knf.com

KNF product centers

Product center for gas pumps:

Germany
KNF Neuberger GmbH
Alter Weg 3
D-79112 Freiburg
Tel. 0049(0)7664 5909-0
Fax 0049(0)7664 5909-99
E-mail: info@knf.de
www.knf.de

Product center for liquid pumps:

Switzerland
KNF FLODOS AG
Wassermatte 2
CH-6210 Sursee
Tel. 0041(0)41 925 00 25
Fax 0041(0)41 925 00 35
E-mail: info@knf-flodos.ch
www.knf-flodos.ch

Product center for micro pumps:

Switzerland
KNF Micro AG
Zelglimatte 1b
CH-6260 Reiden
Tel. 0041(0)62 787 88 88
Fax 0041(0)62 787 88 99
E-mail: info@knf-micro.ch
www.knf-micro.ch